

US FOREST SERVICE SIGN CATALOG 2023-2024

GSA Advantage![®]

Visit GSAAdvantage.gov and search
GSA contract # GS-03F-074DA to
view our discounted pricing!



US FOREST SERVICE SIGNS & MORE

970-641-1675

www.woodproductsigns.com



Made in the USA
Parlin, Colorado





Wood Product SIGNS

ABOUT US

Wood Product Signs is your one stop sign shop that has been an approved vendor for the Forest Service since 1986!

We offer computer routed signs (HDPE Plastic, Western Red Cedar, Oak, Sign Foam & MDO Plywood), Reflective HDO Plywood and Aluminum signs, along with everything you need to complete your sign project.

While our customer base continues to grow, we are still a small, family-owned business. We are located in the beautiful Rocky Mountains of Colorado.

All U. S. Forest Service Signs we manufacture are in strict compliance with the EM 7100-15 current specifications.

Custom signs are also available. If there is something that you cannot find in our catalog, please do not hesitate to contact us. Custom sign orders are welcome.

1-970-641-1675

www.woodproductsigns.com



Taylor Heffner, Owner

GSA CERTIFIED
SAM ACTIVE
NFIB & IPP REGISTERED

Quantity Discounts Available!



MEET OUR STAFF!



TAYLOR

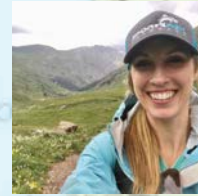

EMILY

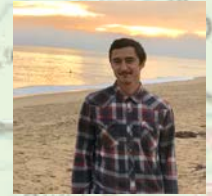

MICHAEL

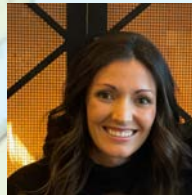

PAITRA

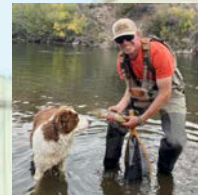

BOBBY



JOSH



CRAIG



ART

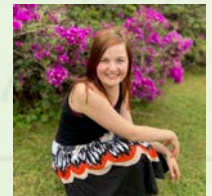

TRINITY



TAYLER



MAPLE & HARLEY



AMY



ORDER BY PHONE
970-641-1675



FIND US ONLINE
www.woodproductsigns.com



CONTACT US BY EMAIL
accounting@woodproductsigns.com



CONTACT US BY MAIL
Wood Product Signs
4890 County Road 76
Parlin, CO 81239



STANDARD FOREST SERVICE SIGNS



USFS SIGNS PRICE LIST

For double-sided signs, order two panels unless sign installation allows for one panel.

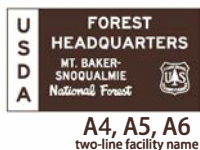

Administrative Site

ASR OR ASL-1	54" x 36"
ASR OR ASL-2	72" x 48"
ASR OR ASL-3	108" x 72"
ASR OR ASL-4	144" x 96"

Administrative Site Signs for Urban Locations

A-1 or A-4	34" x 18"
A-2 or A-5	54" x 30"
A-3 or A-6	94" x 46"

National Forest Boundary Entrance & Leaving

FE OR FL-1	54" x 36"
FE OR FL-2	72" x 48"
FE OR FL-3	108" x 72"
FE OR FL-4	144" x 96"

Minor Forest Boundary Entrance & Leaving

MFE OR MFL-1 Trails	18" X 18"
MFE OR MFL-2 Roads	27" X 27"

National Forest Land Entering & Leaving

NFL-E-1, NFL-L-1 Trails	18" X 18"
NFL-E-2, NFL-L-2 Roads	27" X 27"

Site Approach

SA-1 a, c, e, g, i, or k	38" X 40"
SA-2 b, d, f, h, j or l	48" X 52"

	ROUTED							HIGH INTENSITY PRISMATIC REFLECTIVE
	MDO UNFINISHED	MDO PAINT	CEDAR UNFINISHED	CEDAR PAINT/STAIN	HDPE PLASTIC	HDO PLYWOOD	ALUMINUM	
ASR OR ASL-1								
ASR OR ASL-2								
ASR OR ASL-3								
ASR OR ASL-4								
A-1 or A-4								
A-2 or A-5								
A-3 or A-6								
FE OR FL-1								
FE OR FL-2								
FE OR FL-3								
FE OR FL-4								
MFE OR MFL-1 Trails								
MFE OR MFL-2 Roads								
NFL-E-1, NFL-L-1 Trails								
NFL-E-2, NFL-L-2 Roads								
SA-1 a, c, e, g, i, or k								
SA-2 b, d, f, h, j or l								

Call for pricing

Please use sign codes when ordering.
Chart refers to corresponding shield and credit line.

Sign no.	Sign no.	Shield	USDA Credit Line	Road Speed (mph)
AS-1	FE-1	S-10	P-43	0-15
AS-2	FE-2	S-12	P-52	20-25
AS-3	FE-3	S-18	P-80	30-45
AS-4	FE-4	S-24	P-110	50+

USFS SIGNS PRICE LIST

For double-sided signs, order two panels unless sign installation allows for one panel.

		ROUTED							HIGH INTENSITY PRISMATIC REFLECTIVE
		MDO UNFINISHED	MDO PAINT	CEDAR UNFINISHED	CEDAR PAINT/STAIN	HDPE PLASTIC	HDO PLYWOOD	ALUMINUM	
Recreation Site									
RS-1	48" X 30"								
RS-2	63" X 40"								
RS-3	78" X 48"								
RS-4	93" X 60"								
Two Line Site Name									
RSE-1	30" X 14"								
RSE-2	48" X 20"								
RSE-3	60" X 24"								
RSE-4	72" X 28"								
Two Line Forest Name									
RSM1-1	48" X 30"								
RSM1-2	63" X 40"								
RSM1-3	78" X 48"								
RSM1-4	93" X 60"								
Two Line Forest Name									
RSM2-1	48" X 36"								
RSM2-2	63" X 48"								
RSM2-3	78" X 60"								
RSM2-4	93" X 72"								
Shields									
S-8"									
S-10"									
S-12"									
S-15"									
S-18"									
S-24"									
S-28"									
S-32"									
Credit Lines									
P-37	37" x 3.5"								
P-43	43" X 5.5"								
P-52	52" X 5.5"								
P-68	68" X 6.5"								
P-80	80" X 6.5"								
P-110	110" X 7.5"								

Call for pricing

Call for pricing



RS

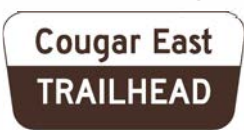

RSE



RSM1



RSM2



SHIELD



CREDIT LINE

Please use sign codes when ordering. Chart refers to corresponding shield and credit line.

Sign no.	Shield	USDA Credit Line	Road Speed (mph)
RS-1	S-10	P-37	0-15
RS-2	S-12	P-43	20-25
RS-3	S-12	P-52	30-45
RS-4	S-15	P-68	50+

USFS SIGNS PRICE LIST

For double-sided signs, order two panels unless sign installation allows for one panel.



NRA-REC



NRA-BDY



NRA-L



NRA-E



NRA-L



NRA-E



MSA-L



MSA-E

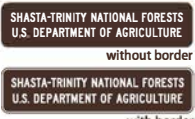

NRA-P10

National Recreation Area

NRA-REC-1	48" X 36"
NRA-REC-2	63" X 48"
NRA-REC-3	78" X 60"
NRA-REC-4	93" X 72"

NRA Boundary Sign Entrance & Leaving

NRA-BDY-E OR L-2	63" X 48"
NRA-BDY-E OR L-3	78" X 60"
NRA-BDY-E OR L-4	93" X 72"
NRA-BDY-E OR L-5	108" X 84"

NRA Entrance & Leaving

One Line Forest Name

NRA-E OR L-1	54" X 36"
NRA-E OR L-2	72" X 48"
NRA-E OR L-3	108" X 72"
NRA-E OR L-4	144" X 96"

Two Line Forest Name

NRA-E OR L-5	54" X 36"
NRA-E OR L-6	72" X 48"
NRA-E OR L-7	108" X 72"
NRA-E OR L-8	144" X 96"

Minor Special Area Entrance & Leaving

MSA-E OR L	27" X 27"
------------	-----------

NRA-USDA Credit Line #2

please specify with or without border

NRA-P10	48" X 10" *
NRA-P12	72" X 12" *

*length and price may vary

	ROUTED						HIGH INTENSITY PRISMATIC REFLECTIVE
	MDO UNFINISHED	MDO PAINT	CEDAR UNFINISHED	CEDAR PAINT/STAIN	HDPE PLASTIC	HDO PLYWOOD	ALUMINUM
NRA-REC-1							
NRA-REC-2							
NRA-REC-3							
NRA-REC-4							
NRA-BDY-E OR L-2							
NRA-BDY-E OR L-3							
NRA-BDY-E OR L-4							
NRA-BDY-E OR L-5							
NRA-E OR L-1							
NRA-E OR L-2							
NRA-E OR L-3							
NRA-E OR L-4							
NRA-E OR L-5							
NRA-E OR L-6							
NRA-E OR L-7							
NRA-E OR L-8							
MSA-E OR L							
NRA-P10							
NRA-P12							

Call for pricing

Call for pricing

INTERAGENCY SIGNS

For double-sided signs, order two panels unless sign installation allows for one panel.

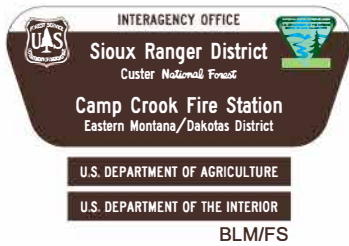

BLM EMBLEM



SHIELD

BLM/FS Interagency Office Signs

BLM/FS-1	72" x 27"
BLM/FS-2	96" x 36"
BLM/FS-3	120" x 45"
BLM/FS-4	144" x 54"

BLM Emblem

BLM-10"
BLM-14"
BLM-16"
BLM-20"

The BLM Emblems are digital graphics mounted to plexiglass and inset into a routed cedar or hdpe pocket.

USFS Shield

S-10"
S-14"
S-16"
S-20"

Special shield sizes are for the Interagency sign only.

	MDO UNFINISHED	MDO PAINT	CEDAR UNFINISHED	CEDAR PAINT/STAIN	HDPE PLASTIC	HDO PLYWOOD	ALUMINUM
BLM/FS-1							
BLM/FS-2							
BLM/FS-3							
BLM/FS-4							
BLM-10"							
BLM-14"							
BLM-16"							
BLM-20"							
S-10"							
S-14"							
S-16"							
S-20"							

Call for pricing

Call for pricing

TRAIL SIGNS

Trail Destination

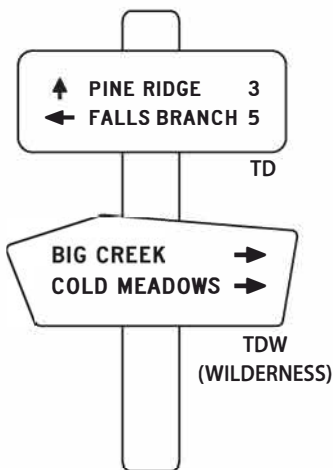

	TD	TDW
routed	MDO UNFINISHED	
	MDO PAINT	
	CEDAR UNFINISHED*	
	CEDAR PAINT/STAIN	
	HDPE PLASTIC	
	OAK* (ADD \$5.00 PER LINE FOR BLACK TEXT)	
	*ADD \$7 PER SIGN FOR CLEAR STAIN ON OAK OR UNPAINTED CEDAR SIGNS.	

Call for pricing

Trail Sign Pricing Information

- Prices are charged per 1" letter and arrow.
- There is no base price for the sign.
- Total number of letters & arrows multiplied by the price of letter equals the cost of the sign.
- Text is all UPPER CASE.

TD-1 (1 line of text) - 5" tall sign
TD-2 (2 lines of text) - 7" tall sign
TD-3 (3 lines of text) - 9" tall sign
TD-4 (4 lines of text) - 11" tall sign
TD-5 (5 lines of text) - 13" tall sign



routed hdpe plastic



routed oak/scorched



routed cedar/paint & stain



routed cedar/unfinished



routed hdpe plastic/custom

NATIONAL SCENIC TRAIL MARKERS

Reflective Aluminum

NT-1 3.5"

NT-2 9"

NT-3 18"



Quantity Discount Pricing (for 3.5" only):

1-49 = 50-99 = 100-249 = 250+ =

Please send us the artwork to order your National Trail Markers today!

WILDERNESS SIGNS

high point of sign
faces road or trail

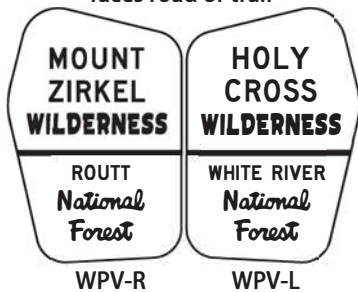

Wilderness Primitive Area Signs

WPV-1 L OR R 13" x 18"

WPV-2 L OR R 24" x 36"

WPH-1 L OR R 40" X 20"

WPH-2 L OR R 60" X 30"

Wilderness Primitive Area Shields & Credit Lines

WP-PH 42" X 3.5" (Credit Line)

WP-PV 22" X 3" (Credit Line)

WP-S-10 (Shield) 10"

WP-S-12 (Shield) 12"



U.S. DEPARTMENT OF AGRICULTURE

WP-PH OR WP-PV



WP-S-10
Shield



routed hdpe plastic



routed oak/scorched



weathered routed oak/scorched

routed

CEDAR UNFINISHED	CEDAR UNFINISHED PAINTED BLACK LETTERS	OAK UNFINISHED	OAK UNFINISHED SCORCHED BLACK LETTERS	HDPE PLASTIC GRAY/BLACK
------------------	--	----------------	---------------------------------------	-------------------------

Call for pricing

Add clear or gray stain
\$24 for a 36" sign or \$19 for a 18" sign

Call for pricing

MARKERS



Marker Option 1

HDPE Plastic
Aluminum
4" x 4" with 2" Number



Marker Option 2

HDPE Plastic
Aluminum
3.5" x 5" with 2" or 3" Number



Marker Option 3

HDPE Plastic
Aluminum
8" x 6" with 3" Number



Bear Paw Marker

HDPE Plastic
Aluminum
7" x 9" with 2.5" Number



PCT Marker

Laser Engraved Oak
5.5" x 5.5" / Scalloped Edges

Custom Marker Sizes Are Available

POSTS

Unfinished

		5'	8'	10'	12'
4" x 4"	S4S-Cedar Tone CA-C Pit				
4" x 4"	S4S-Western Red Cedar				
4" x 4"	RS-Western Red Cedar				
6" x 6"	S4S - Cedar Tone CA-C Pit				
6" x 6"	RS-Western Red Cedar				

Chamfer Top with Stain

		5'	8'	10'	12'
4" x 4"	S4S-Cedar Tone CA-C Pit				
4" x 4"	S4S-Western Red Cedar				
4" x 4"	RS-Western Red Cedar				
6" x 6"	S4S - Cedar Tone CA-C Pit				
6" x 6"	RS-Western Red Cedar				

Nominal
Sizes

Call for pricing

Post Options

- Glass Beads
- HDPE Routed
- Aluminum Sign
- Solid Stain
- Transparent Stain
- Chamfer/Angle Top

RS=Rough Sawn

S4S=Smooth 4 Sides

CAC = Copper Treatment

Cedar Routed Post

4" x 4" x 6' Cedar post with routed & unfinished letter.
Routed on 3 sides
Routed on 4 sides
Also available with chamfer and flat top.

Aluminum Marker



Solid Stained CA-C

Transparent Stain



Campsite Markers with Glass Beads

RS Doug Fir



Rough Sawn Douglas Fir Post

CA-C



Copper Azole Treatment

Western Red Cedar



Chamfer Top with Natural Stain

Cedar



with Custom Placards

VANDAL RESISTANT SCREWS BY TUFNUT



- Single Unit 5/16" x 2.5"
- Box of 100 Units 5/16" x 2.5"
- Single Unit 5/16" x 6"
- Box of 100 Units 5/16" x 6"
- Single Unit 5/16" x 8"
- Box of 100 Units 5/16" x 8"

Unit includes: Carriage Bolt Adapter, Tufnut & Black Tufnut Washer.

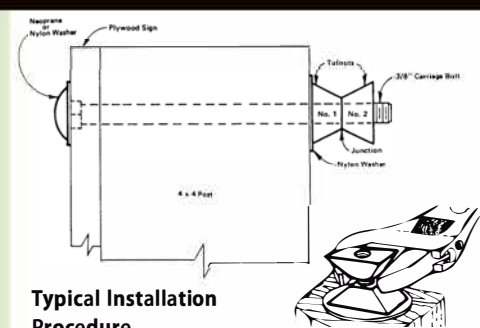

Typical Installation Procedure

- Step 1: Install first Tufnut (No.1) finger tight as shown.
- Step 2: Install second Tufnut (No.2) finger tight as shown.
- Step 3: Insert wrench at junction to tighten (or loosen) as necessary.
- Step 4: Remove Tufnut No. 2, then installation is complete.

BULLETIN BOARDS

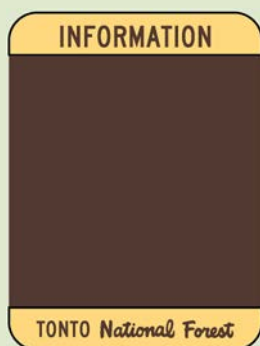

36" x 48" Bulletin Board	48" x 48" Bulletin Board	72" x 48" Bulletin Board
HDPE Standard Panel (no inside message)	HDPE Standard Panel (no inside message)	HDPE Standard Panel (no inside message)
HDPE Watershed Panel (clear lexan cover)	HDPE Watershed Panel (clear lexan cover)	HDPE Watershed Panel (clear lexan cover)
Cedar Standard Panel (black paint/clear stain)	Cedar Standard Panel (black paint/clear stain)	Cedar Standard Panel (black paint/clear stain)

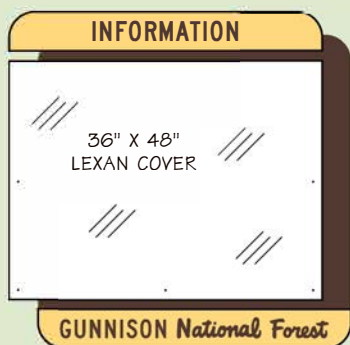

Standard Watershed Panel (includes a clear lexan cover)



**Custom Map/Info Panel with Digital Graphic Inlay



**Custom Fee Panel w/ aluminum channel & sliders

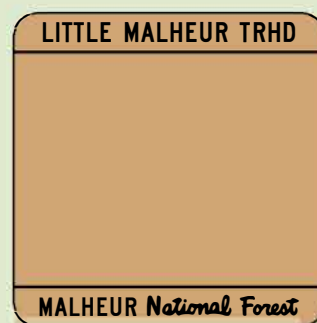

Standard Cedar Panel (black paint/clear stain)

****Please contact us at accounting@woodproductsigns.com for pricing on custom options****

Enclosed Bulletin Boards



Double Door



Single Door

Size	# of doors	Price
18" x 24" x 2"	1	
24" x 36" x 2"	1	
48" x 36" x 2"	2	
48" x 48" x 2"	2	

Aluminum Frames available in: Satin Silver or Anodized Brown

Separate Headers & Footers



	CEDAR Routed/ Painted	HDPE Routed	HDPE Raised
4" x 48"			
6" x 48"			
4" x 72"			
6" x 72"			

WOOD STRUCTURES

Richmond Bulletin Board Kit

62" wide
Additional for Cedar post upgrade

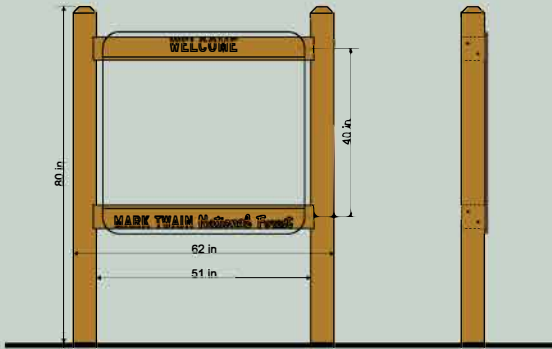

Boise Bulletin Board Kit

69" wide
Additional for Cedar post upgrade

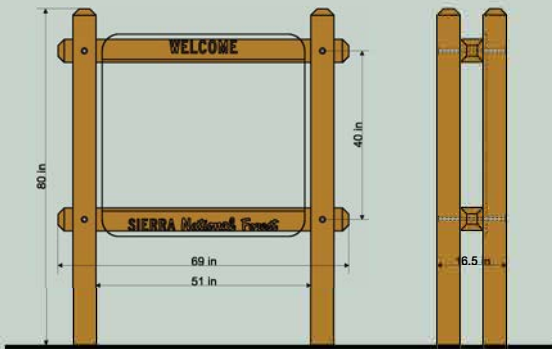

Richmond Double Bulletin Board Kit

118.5" wide
Additional for cedar post upgrade

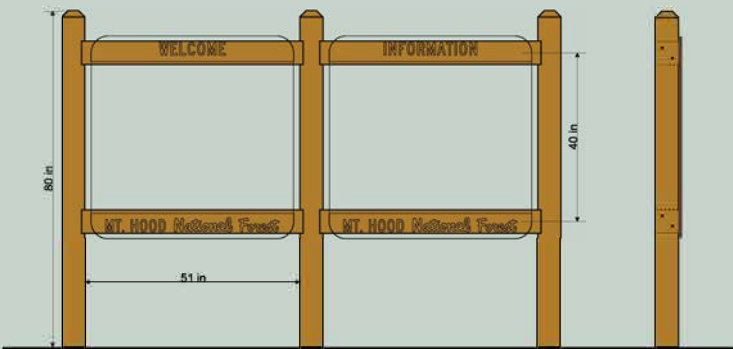

- Bulletin Board Kits include everything except the Bulletin Board Panel - please see page 10 for options and pricing
- Recommended burial is 30"
- CCA-Treated Hem-Fir posts
- Cut & fit to size
- Pre-Drilled
- 9' 2" Vertical Posts

METAL STRUCTURES

Ridgway 50" Bulletin Board Kit

50" wide horizontal crossmember
9' tall vertical post (recommended 32" burial)

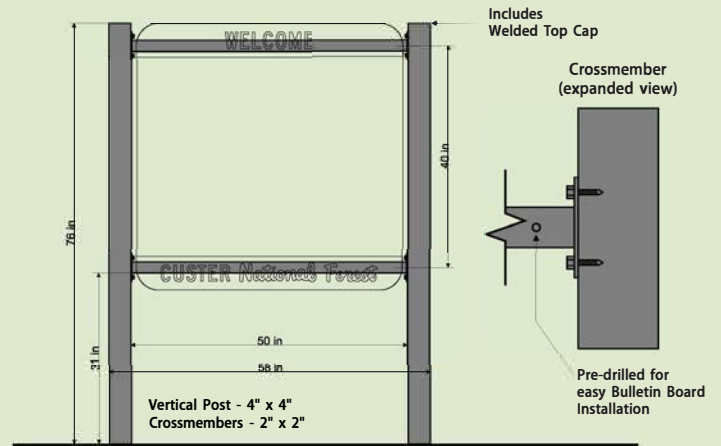

	Raw Metal	Brown Powder Coat
Single - fits (1) 48x48 panel		
Double - fits (2) 48x48 panels		
Triple - fits (3) 48x48 panels		

Call for pricing

Ridgway 74" Bulletin Board Kit

74" wide horizontal crossmember
9' tall vertical post (recommended 32" burial)

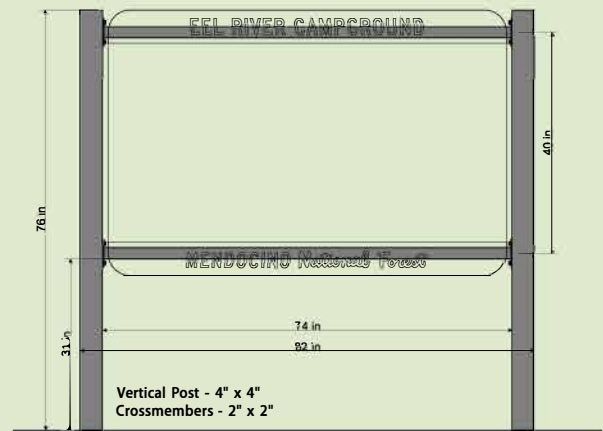

	Raw Metal	Brown Powder Coat
Single - fits (1) 72x48 panel		
Double - fits (2) 72x48 panels		
Triple - fits (3) 72x48 panels		

Call for pricing

STRUCTURES



West Slope Double Roof Kit



Ridgway Bulletin Board Kit



West Slope Single Roof Kit



West Slope Single Roof Kit



West Slope Double w/ Enclosed Bulletin



Custom Park City Roof Kit

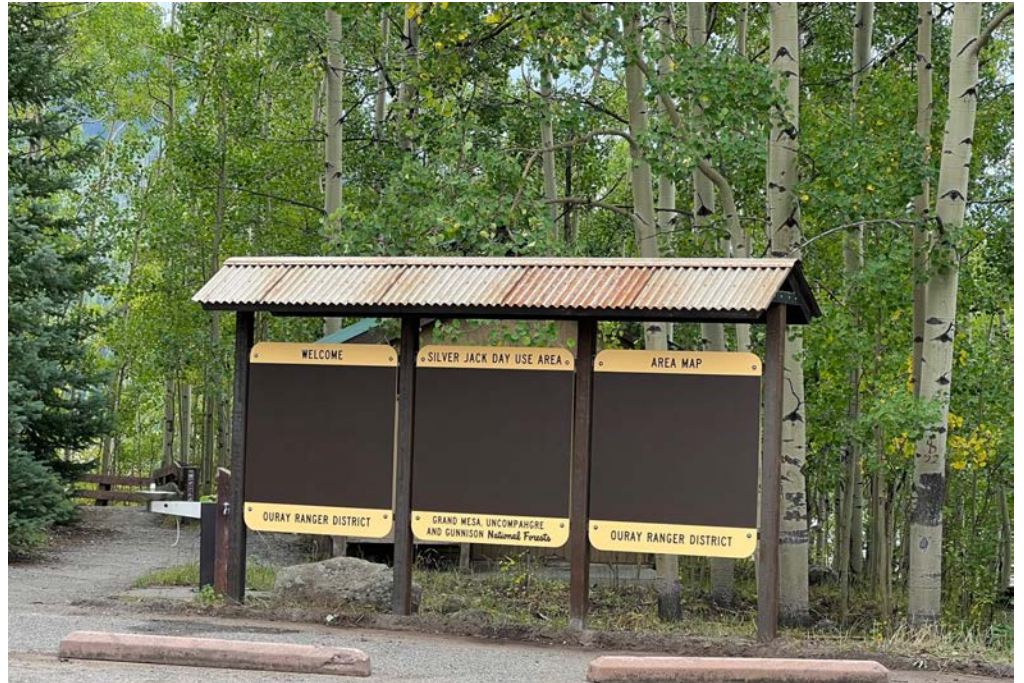

West Slope Triple Roof Kit (only available for sale in Colorado)



California Roof Kit



Virginia Roof Kit



Custom Virginia Roof Kit



Idaho Double Roof Kit



Oregon Roof Kit



Park City Roof Kit



Colorado Triple Roof Kit

WOODEN ROOF KITS

Utah Roof Kit

6' x 8' 5"

- Fits (1) 48" x 48" panel - sold separately (see page 10)
 - CCA-Treated Hem-Fir posts
- Includes Metal Roofing (available in Green or Brown)

6' kit with posts	
6' kit without posts*	

Call for pricing

*customer will need to purchase posts locally

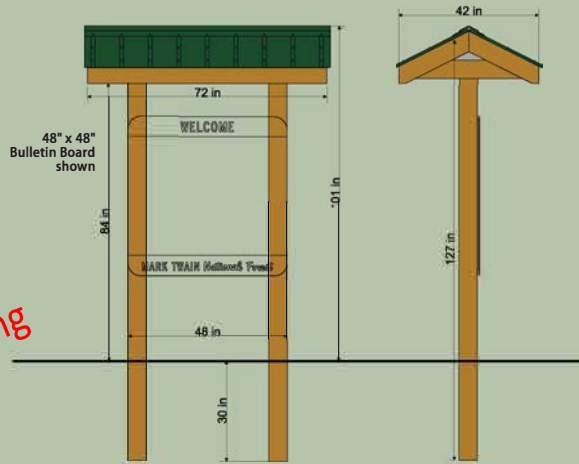

Upgrade Pricing:
Cedar or Doug Fir Posts
Cedar Shingles

Virginia Roof Kit

6', 8' (shown) or 9'

- Includes all posts & horizontal crossmembers
 - CCA-Treated Hem-Fir posts
- Includes Metal Roofing (available in Green or Brown)
- Bulletin Board panels sold separately (see page 10)

6' kit - fits (1) 48x48 panel	
8' kit - fits (2) 36x48 panels	
9' kit - fits (2) 48x48 panels	

Call for pricing

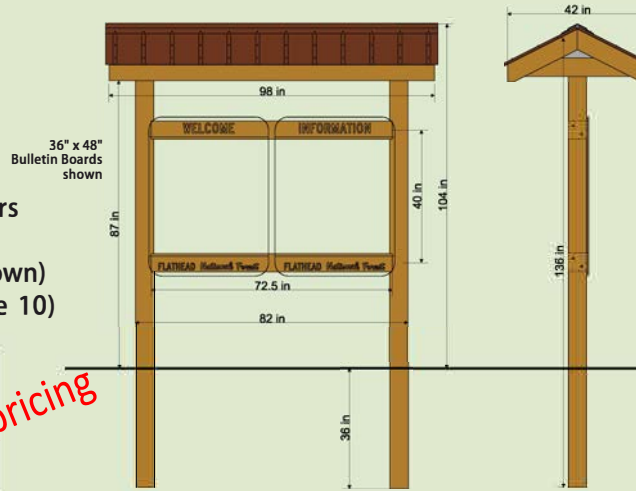

Upgrade Pricing:
Cedar or Doug Fir Posts
Cedar Shingles

CUSTOMER-ASSEMBLED ROOF KIT

6' Utah Roof Kit

Non-Assembled Kit

- Non-assembled kit ships on a small pallet with all roof parts included.
- Easy to assemble. Instructions are available on YouTube.
- Save money on this kit by using your own labor or work crew to assemble.

6' kit without posts*	
8' kit without posts*	

Call for pricing

*customer will need to purchase posts locally

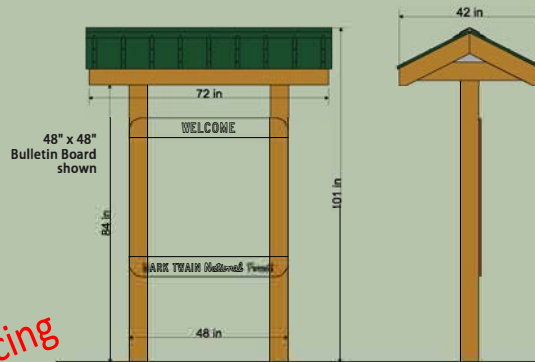

What You Need

- Purchase Qty (2) 12' x 6" x 6" posts from your local lumber supplier.
- OR
- Purchase Qty (2) 12' x 6" x 6" posts from us - see page 9.

Finished Product



Included In The Kit

Trusses 5 Regular & 2 Supertrusses* (*Accepts Post).	Plywood Precut ready to be installed. Also has tri-flex underlayment.	Hardware All screws and all nails needed for assembly.	Fascia All Fascia is 1" x 6". Cedar cut to fit. Stained.	Metal Roof Precut and drilled metal. Choose from color chart.	Instructions A step by step assembly video is available on YouTube.
--	--	---	---	--	--

METAL ROOF KITS

West Slope Single Roof Kit

- Fits (1) 48" x 48" panel - sold separately (see page 10)
- Roof available in Raw 22 gauge Corten Steel, or Green or Brown roof metal
- See page 12 for photo examples

	Raw Metal	Brown Powder Coat*
Single - fits (1) 48x48 panel	Call for pricing	

*Only Posts and Crossmembers come powder coated

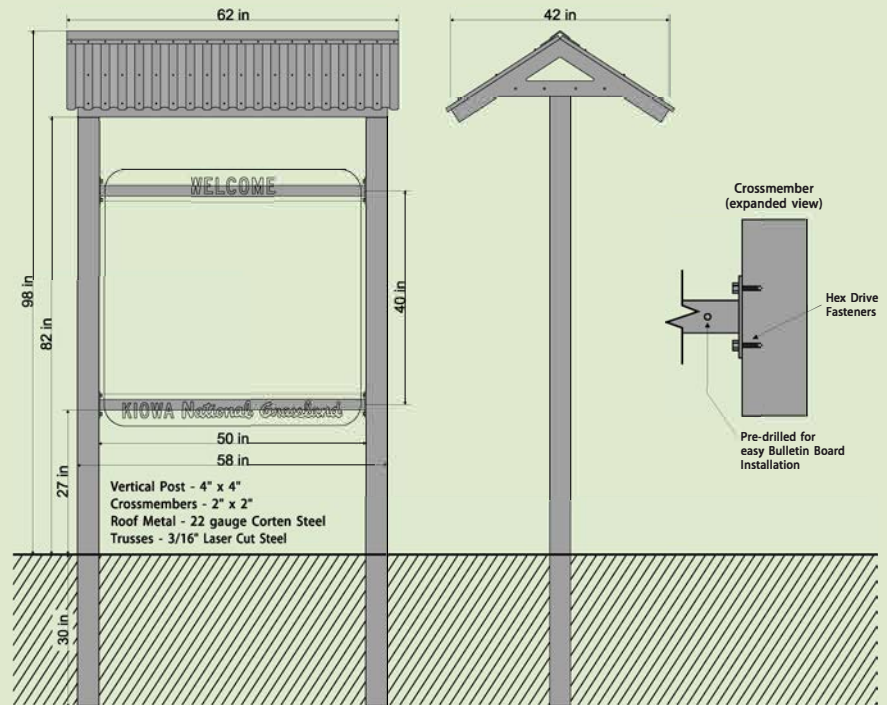

West Slope Double Roof Kit

- Fits (2) 48" x 48" panels - sold separately (see page 10)
- Roof available in Raw 22 gauge Corten Steel, or Green or Brown roof metal
- See page 12 for photo examples

	Raw Metal	Brown Powder Coat*
Double - fits (2) 48x48 panels	Call for pricing	

*Only Posts and Crossmembers come powder coated

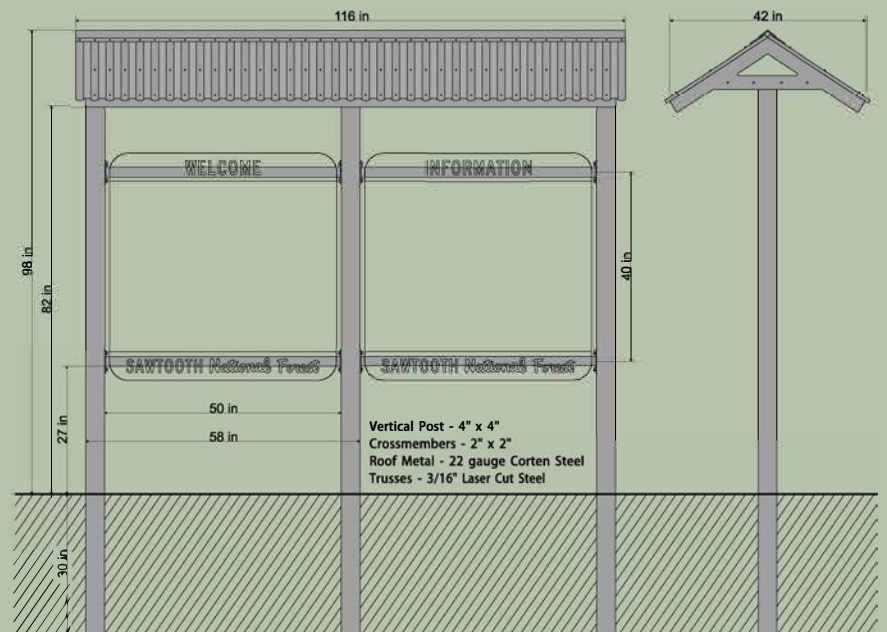

Surface Mount Option

- Hardware included
- add \$100 per post

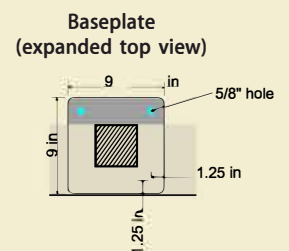
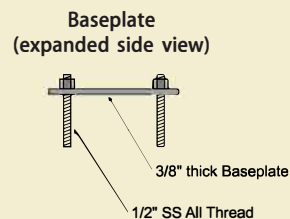
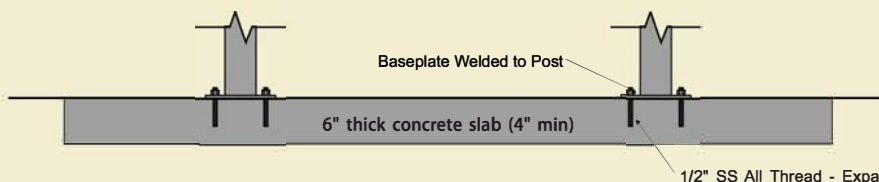

RS SIGN BASES



RS-2 Sign Base



Sign Base Pricing
RS-1
RS-2
RS-3 *Call for pricing*



RS-1 Sign Base



Ridgway Reservoir - Ouray County, Colorado

SMOKEY BEAR FIRE RATING SIGN

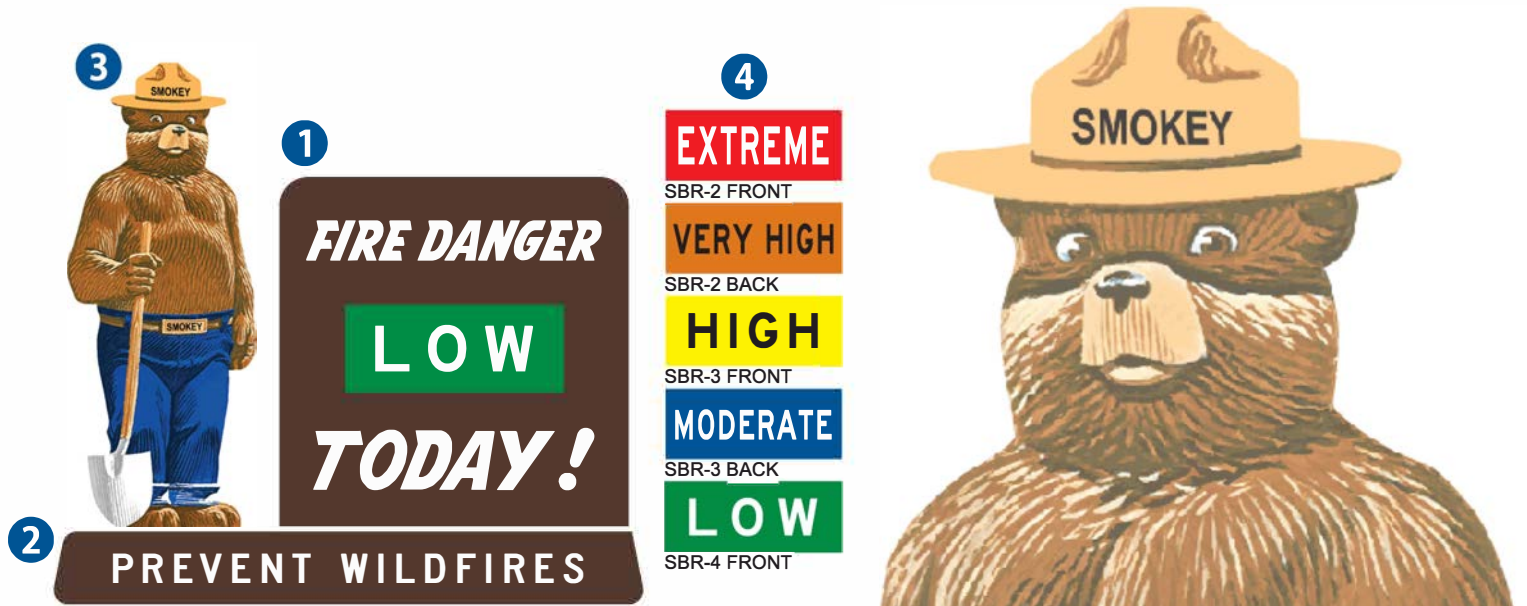

Each set consists of 4 parts.
Order *one* of each for *single-sided* set.
Order *two* of each for *double-sided* set.
Specify right or left handed bear.

1	FIRE DANGER TODAY	48" x 48"
2	PREVENT WILDFIRES	81" x 10"
3	Smokey Bear	26" x 64"
4	Fire Rating - Set of 3 Panels	30" x 12"

Material	Color
HDPE Plastic	Brown/Yellow Cream
Reflective HDO	Brown/White
Reflective Aluminum	Brown/White

Total Price Per Set (all 4 parts)
with HDPE Plastic for parts 1 and 2 and HDO Plywood for part 3
with Reflective HDO for parts 1, 2, and 3
with all Reflective Aluminum

Call for pricing

Custom Sizes Are Available

FIRE WHEEL RATING SIGN



60" x 36" Aluminum Fire Wheel Rating Sign

.125" thick Retroreflective Aluminum or .625" thick Retroreflective HDO Plywood.
Fire Wheel is easily movable to show current fire conditions.
Visible both day and night.

Material	Color
Reflective HDO	Brown/White
Reflective Aluminum	Brown/White

48" x 24"	Call for pricing
60" x 36"	
72" x 48"	

FOREST ROAD DESTINATION SIGNS (FRDs)

- We offer FRD signs made out of High Intensity Prismatic Reflective Sheeting on Aluminum or HDO Plywood backing.
- The size of the sign is determined by the length of the message and size of the lettering.
- Prices are calculated based on square footage once the sign size is determined.

TEXT SIZE EXAMPLES

Examples of how the sign size will change depending on the letter size.



Ordering is easy!

- Determine the road type and speed for letter size. You may want to measure the text on existing signs in your area to get a better idea of the size you need.
- Send us your sign message, letter size, and material (HDO Plywood or Aluminum).
- We will send you a quote with approximate sign sizes. USFS specs call for upper and lowercase lettering. We will follow those specs unless otherwise instructed.
- Once the order is placed we will send you layouts of each sign.

Table 3C-1—Legend and symbol size for guide signs on NFS roads

Speed (mph)	Upper Case Letters and Numbers* Minimum Size (inches)		Symbols Minimum Size (inches)	
	Conventional Roads	Low-Volume Roads	Conventional Roads	Low-Volume Roads
50 and over	6	6	24	24
30-45	6	5	24	24
20-25	6	4	24	18
15 and under	6	3	24	12

*The size of lower case letters are ¾ the height of the upper case letters.

ADDITIONAL OPTIONS/ADD-ONS FOR FRD SIGNS



Clear Coat

- Highly recommended for harsh conditions/snow burial areas



Brown Vinyl Backing

- For highly visible areas to reduce glare off the sign back

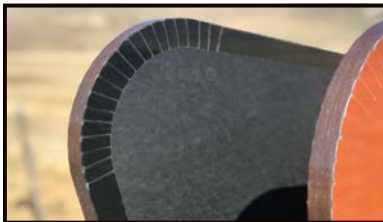

Edge Tape

- Recommended for snow burial areas



Sliders

- Open & Closed, Seasonal Closures, or Custom Messages
- Security feature/locks available



Z Bar

- Use to stiffen sign and/or allow for alternate mounting options
- Available as raw aluminum or powder coated brown



Digital Graphics

- Add extra detail, color, small USFS shields, or Interagency logos

ALUMINUM & HDO SIGNS



Custom Aluminum Sign & Wood Base - Lake Tahoe



NATIONAL WILD & SCENIC RIVER SIGNS

WSR



* pricing will vary depending on sign length

- WSR-1 (*)" x 18"
- WSR-2 (*)" x 24"
- WSR-3 (*)" x 30"
- WSR-4 (*)" x 36"



Scorched Oak WSR-L

WSR-L



Full Color Aluminum or Painted Cedar



Scorched Oak

- WSR-L1 10.25" x 12"
- WSR-L2 15.5" x 18"
- WSR-L3 20.75" x 24"
- WSR-L4 25.75" x 30"
- WSR-L5 31" x 36"

WSRa



WSRa length and height may be adjusted to accommodate longer names

- WSRa-1 18" x 12"
- WSRa-2 24" x 16"
- WSRa-3 30" x 20"
- WSRa-4 36" x 22"



Painted Cedar WSR-L

ADOPT-A-TRAIL



12" x 18"

Call for pricing



12" x 6"

SCENIC BYWAY

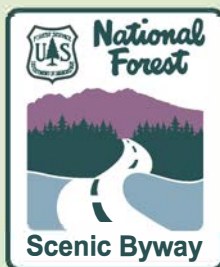

SB-1 24" x 30"

Call for pricing

SB-2 30" x 36"

SB-3 36" x 48"

SB-4 48" x 60"

FEE AREA



FA-1 9" x 9"

12" x 12"

FA-2 18" x 18"

Call for pricing

TRAFFIC CONTROL SIGNS

MUTCD Signs
 All standardized MUTCD signs are available and made with High Intensity Prismatic Reflective Sheeting in compliance with all U.S. Forest Service Specifications. Available in HDO Plywood or Aluminum.



R1-1



R5-1



R1-2



R8-3a



R5-1a



R3-2



R5-2a



R1-3



R2-1



R4-7A



R6-2R



R6-2L



R4-1

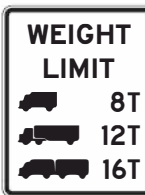

R12-5



R12-1



OM 6" x 12"



BM-L



BM-R

8" x 24"

\$28



R7-8



R7-8A



R7-8B



R7-1D



R8-3



R7-2



R7-1



R7-5



OM-3R

OM-3L

12" x 36"

\$62



FW3-5A



FW3-6A



FW3-4A



FW8-7



W1-6r



W1-7



W1-4



W11-1



W11-2



W11-6



W1-11l



W8-1



W11-3



W16-2

SIGN PRICE BY SIZE

	HDO PLYWOOD	ALUMINUM
12" x 6"		
12" x 12"		
12" x 18"		
18" x 24"		
24" x 24"		
24" x 36"		
30" x 30"		
36" x 36"		
36" x 48"		
48" x 48"		

Call for pricing

Please refer to your USFS Sign Manual for additional signs and sign numbers or give us a call today!

Prices are for quantity of one. Volume discounts may be available.

ROUTE MARKERS & SIGNS

High Intensity Prismatic Reflective		HDO PLYWOOD	ALUMINUM
Forest Route Markers			
M1-7-18	18" X 18"		
M1-7-24	24" X 24"		
FM1-7H-16	16" X 8"		
FM1-7H-21	21" X 8"		
FM1-7H-20	20" X 10"		
FM1-7H-28	28" X 10"		
FM1-7H-26	26" X 12"		
FM1-7H-36	36" X 12"		
M5 & M6	12" x 9"		
M5 & M6	16" x 12"		
M5 & M6*	21" x 15"		
FM 2-1	12" x 8"		
FM 4-5	12" x 8"		
FM 4-6	12" x 8"		
FM3-1	18" x 8"		
FM3-2	18" x 8"		
FM3-3	18" x 8"		
FM3-4	18" x 8"		

Call for pricing

*For use with SA-1 & SA-2 signs

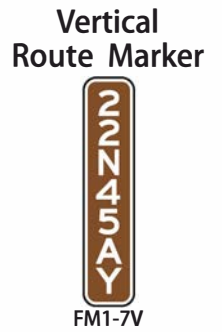

Directional Arrow Auxiliary Signs

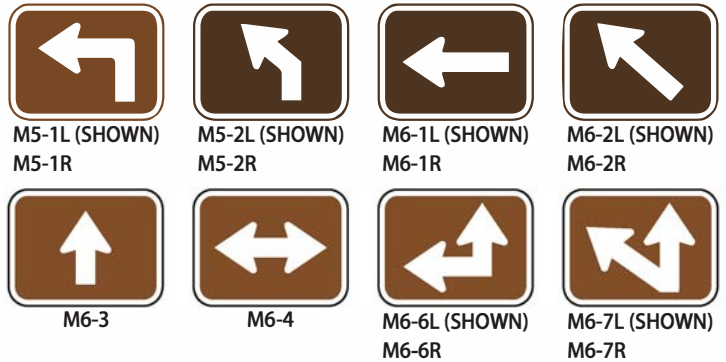

Auxiliary Route Markers



TRAVEL MANAGEMENT SIGNS

Aluminum or HDO Plywood



Examples of travel management signs (TM).

TM-1 12" x 18"

TM-2 18" x 24"

Additional one-time \$25 setup fee may apply.

Decals for use on flexible posts



Examples of (TM-D) decals.

RECREATION & MUTCD SYMBOLS

Recreational and Cultural Interest Area Symbol Signs for General Applications



Recreational and Cultural Interest Area Symbol Signs for Accommodations

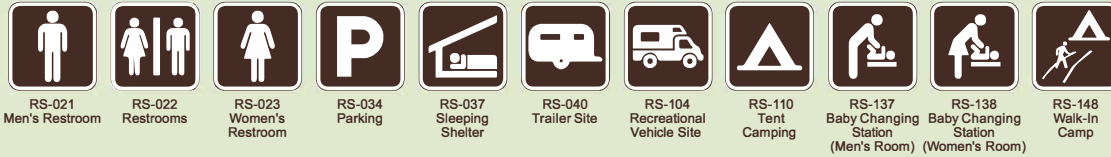

Recreational and Cultural Interest Area Symbol Signs for Services

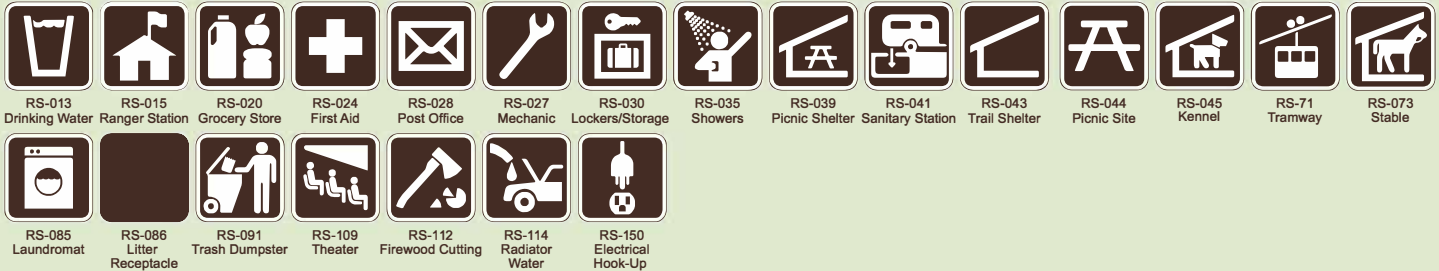

Recreational and Cultural Interest Area Symbol Signs for Water Recreation



Recreational and Cultural Interest Area Symbol Signs for Land Recreation



Recreational and Cultural Interest Area Symbol Signs for Winter Recreation



Red slashes can be added to any recreation symbol for an additional charge.

ROUTED				REFLECTIVE	
MDO UNFINISHED	MDO PAINT	CEDAR UNFINISHED	CEDAR PAINT/STAIN	HDPE PLASTIC	HDO PLYWOOD ALUMINUM
9" X 9"	12" X 12"	18" X 18"	24" X 24"		
Call for pricing					

CUSTOM SIGNS



HDPE



CHPL with Metal Bases



HDPE



Sign Foam



HDPE



CHPL with Custom Metal Base



HDPE

DIGITAL GRAPHICS



ABOUT DIGITAL GRAPHICS

- Digital graphics allow for a wide variety of images and colors to be used on a sign.
- Many signs we make include the application of a digital graphic for a logo or a detailed map.
- A full color digital graphic is printed and then applied to a backing - typically aluminum or HDO plywood. The digital graphic can also be applied to a thin material such as lexan and then inset into a plastic or wood sign.
- We can print digital graphic stickers for you to apply on-site.
- Digital graphics can be non-reflective or reflective. Clear overlay is applied to each graphic for protection.

ORDERING

- In order to supply you with the highest quality digital graphic available, please provide a high quality file in either of the following formats: .jpg, .eps, .pdf, .tif or a vector format such as an .ai or .eps. If you are not sure of your artwork format, feel free to contact us.
- Please specify any pantone colors if necessary and we will match as close as possible.
- Artwork may be subject to a one time set up fee.
- All digital graphics will be printed on 3M 3290 Reflective Sheeting and receive 3M's 1170 Clear Film unless otherwise noted.

SIGN MATERIALS

Routed



MDO Plywood

- 3/4" thick
- routed
- painted
- 7-10 year average life



White Oak

- 3/4" thick
- routed
- unfinished or scorched
- 15-20 year average life



Western Red Cedar

- 1 1/2" thick
- routed or sandblasted
- unfinished or stained background with painted text
- clear all heart vertical grain
- 15-20 year average life



HDPE Plastic

- 3/4" or 1/2" thick
- routed top layer reveals center color
- no paint/no maintenance
- vandal resistant
- contains recycled components
- textured finish
- 20+ year average life

Reflective



HDO Plywood

- 5/8" thick
- sheeted with high intensity prismatic
- black back, painted edges
- 7-10 year average life

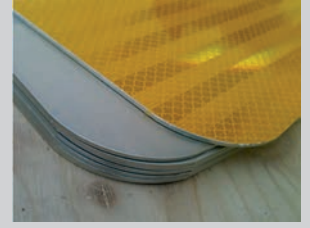

Aluminum

- 0.080" or .125" thick
- sheeted with high intensity prismatic
- corrosion and rust resistant
- 7-10 year average life

Aluminum Sheeting/Overlay Options

Aluminum signs may be sheeted with one of the following reflective products:

- 3M 3290 Engineer Grade (Less Reflective)
- 3M 3930 High Intensity Prismatic (More Reflective)
- 3M 4090 Diamond Grade (Most Reflective)



Unless noted all signs will be manufactured with HIP sheeting (High Intensity Prismatic) with 3M 1170 ElectroCut Film applied over the top. Upon request 3M 1170 Clear Film will be applied for a clear coat overlay. All digital graphics will be printed on 3M 3290 Reflective Sheeting and receive 3M's 1170 Clear Film unless otherwise noted.

SIGN INSTALLATION GUIDELINES

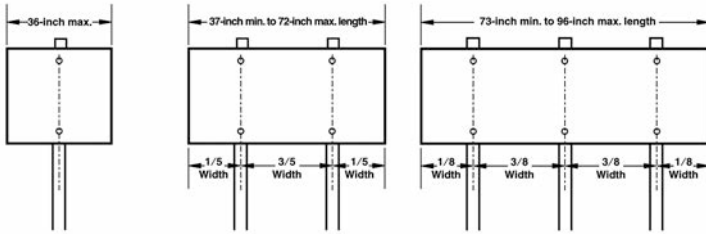

Typical Single-Post Detail Typical Two-Post Detail* Typical Three-Post Detail* (Nonbreakaway installation)

Wood Post Size** (in)	One post		Two posts		Three posts	
	Max. width (in)	Max. sign area (sq. ft)	Max. width (in)	Max. sign area (sq. ft)	Max. width (in)	Max. sign area (sq. ft)
4 by 4	36	10	72	20	96	30
4 by 6	36	20	72	50	144	75
6 by 6	36	20	96	95	—	—



Custom Framework with Cross Braces



Richmond Bulletin Board Kit



Wood Cross Braces

HDPE Plastic Sign Installation

Expansion and Contraction

Due to fluctuation in weather temperatures the HDPE plastic sign material will expand or contract at a maximum rate of .03" per foot depending on sign color selected. Installation design considerations must be applied in order to compensate for sign material expansion or contraction. This material must have room to move freely.

Oversize All Drilled Holes in HDPE Signs

All holes drilled must be oversized a minimum of 1/8" to 1/4" than the bolt used to prevent the sign from cracking. Use of bolts/fasteners is recommended and they should be loosely fastened to allow movement of expansion or contraction. DO NOT over tighten bolts! The HDPE plastic sign material is very easy to drill. HDPE Plastic signs do not come pre-drilled.

Use Wood Cross Braces

We highly recommend mounting all HDPE plastic signs to wood posts and using 2 or more wood cross braces depending on the size of the sign. The maximum space between the cross braces should be no more than 3 feet. Deck screws may be used to attach the cross braces to the sign, these holes do not have to be oversized. 12" - 18" is recommended for spacing of the deck screws.

Please view our website for further instructions on HDPE Plastic sign installation or call for more information.